



INSTALLATION & SAFETY INSTRUCTIONS

DIY Installation instructions for a rectangular Capital In-ground Trampoline.
(Including assembly of the optional safety enclosures)



10ft x 6ft
(3.05m x 1.85m)



11ft x 8ft
(3.35m x 2.45m)



14ft x 10ft
(4.25m x 3.05m)



Tel: 01276 855600
sales@capitalplay.co.uk
www.capitalplay.co.uk



Tel: 1-800-510-8734
sales@capitalplay.com
www.capitalplay.com

capitalplay



WELCOME

**Thank you for choosing a Capital In-ground Trampoline.
Our high quality trampolines are designed to give
you peace of mind and provide your children
with many years of fun.**

Please refer to the enclosed assembly and instruction manual,
or refer to the installation section on our website



www.capitalplay.co.uk



www.capitalplay.com

SAFETY CERTIFICATION

Capital In-ground Trampoline Kits conform to the relevant parts of the
new EN71-14 'Trampolines for Domestic Use' safety standard.

The Capital In-ground Trampoline Kits are primarily designed for domestic
use and not for commercial use and do not conform to EN 1176 –
Playground Equipment Standard.

If you are planning to install this trampoline in a non-domestic
environment, we highly recommend you contact your insurance company
to ensure you are able to install the Capital In-ground Trampoline in your
intended location.





CONTENTS

Parts List	5-6
Assemble trampoline frame	7
Dig the hole	8-10
Attach the retaining wall	11
Placing the trampoline into the hole	12
Attach jumpmat and springs	13
Backfill the hole	14
Attaching the vented pads	15
Installing the optional trampoline enclosure	16-18
Safety Information UK	19
Safety Information USA	20
Using Your Trampoline	21
Care & Maintenance	22

PARTS LIST 11ft x 8ft (335cm x 245cm) / 10ft x 6ft (305cm x 185cm)

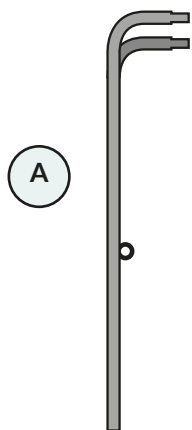

A

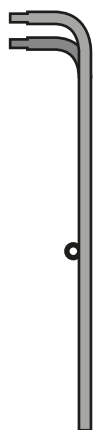

B

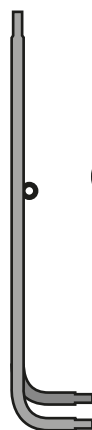

C



D

Corner Section
(One end tapered, one end non tapered)

1

Corner Section
(One end tapered, one end non tapered)

1

Corner Section
Both ends tapered

1

Corner Section
Both ends tapered

1

E



F



Middle Section
One end tapered, one end non tapered

2

Middle Section
Both ends non tapered

2

Wall Panels
Quantity: 4 (4 Corner Holes)
Quantity: 4 (4 Corner + Inner Holes)



Jump Mat

1



Springs

10x6ft (3.05m x 1.85m) = (68 x 7")
11x8 (3.35m x 2.45m) = (80 x 8.5")

80



Spring Tool

1



Self Tapping Screws

48 + 2 extra



Safety Pads

1



Elastic Toggles

16



Tel: 01276 855600
sales@capitalplay.co.uk
www.capitalplay.co.uk



Tel: 1-800-510-8734
sales@capitalplay.com
www.capitalplay.com

PARTS LIST 14ft x 10ft (425cm x 305cm)

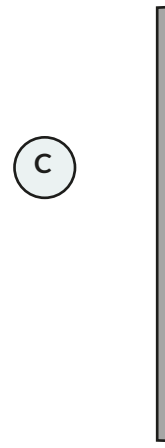
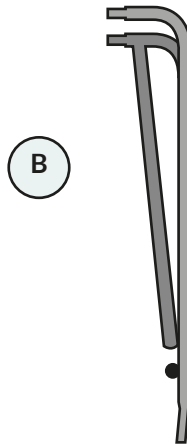
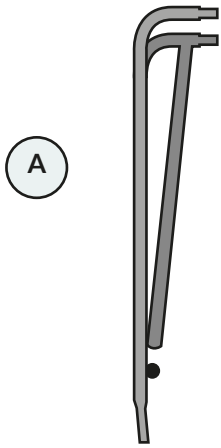

Corner Section
(Both ends tapered) **2**

Corner Section
(Both ends tapered) **2**

Middle Section
Both ends non tapered **2**

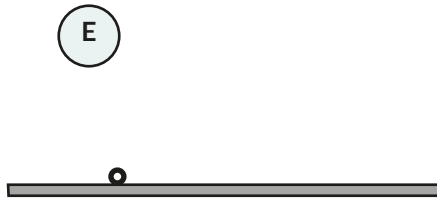
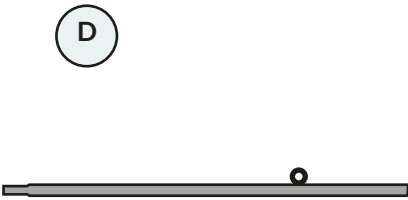

Middle Section
One end tapered,
one end non tapered **2**

Middle Section
Both ends non tapered **2**

Wall Panels
Quantity: 4 (4 Corner Holes)
Quantity: 4 (4 Corner + Inner Holes)

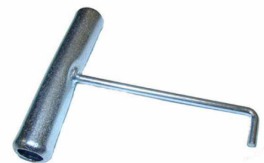

Jump Mat **1**

Springs **104**

Spring Tool **1**

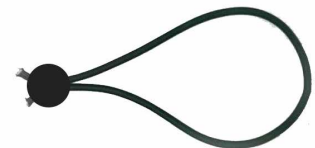

Self Tapping Screws **48 + 2 extra**

Safety Pads **1**

Elastic Toggles **16**

ASSEMBLE THE FRAME

Time required

You will need two people to assemble the trampoline and wall. You should allow approximately 30 minutes for this stage.



You will need

- Cross-head screwdriver or electric drill (for attaching the retaining wall panels).
- Safety goggles and gloves (for attaching the springs).



Please Note: On the long sides, the frame will appear to bow outwards – this is by design. When the springs are attached the frame will pull inwards, but will always have a slight outward bow.

Important note: all trampoline sizes are approximate and can be up to +/- 3" (2.5cm) different to those that we publish. For clarification on any sizing questions please call Capital Play on 0044 1276 855600 or 1-800-510-8734.

Lay out the frame as pictured below with the spring holes facing upwards. Push all sections together ensuring they're all fully connected.

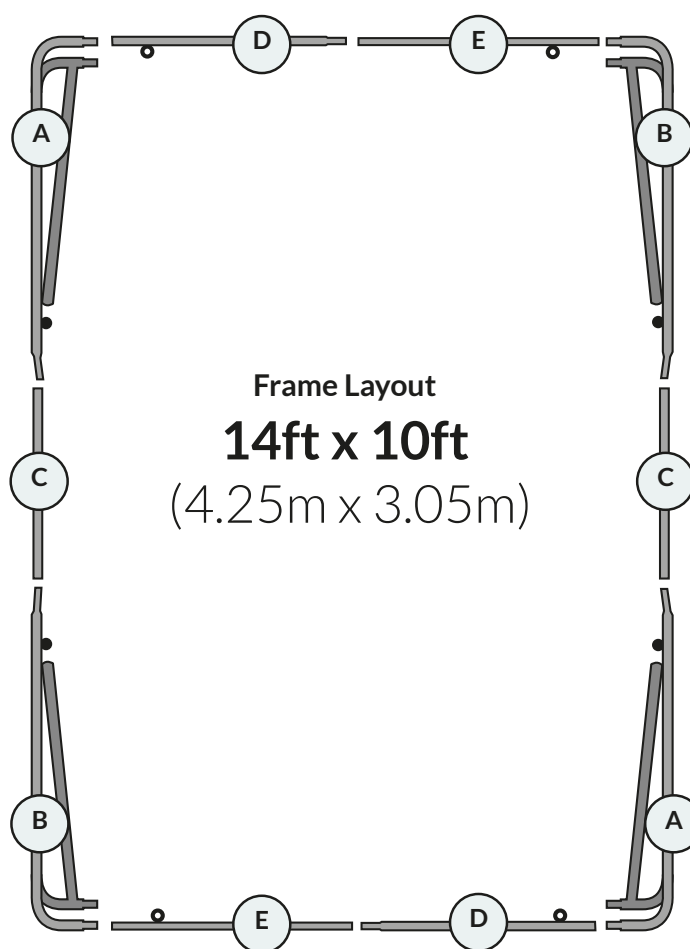
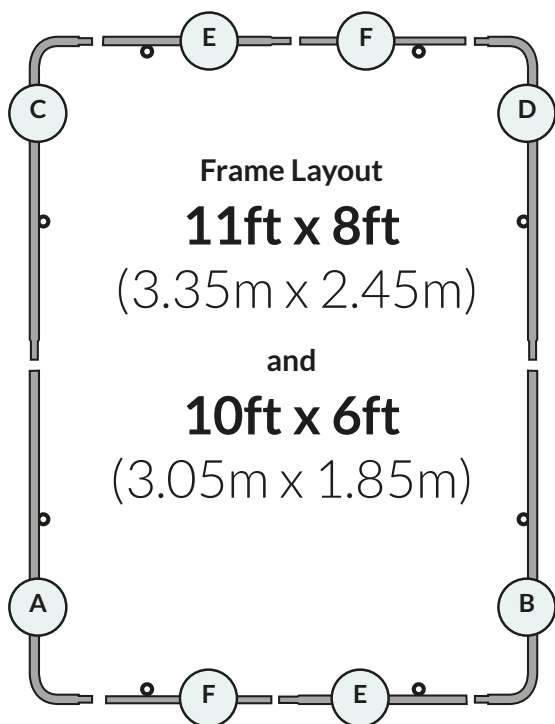

Tel: 01276 855600
sales@capitalplay.co.uk
www.capitalplay.co.uk



Tel: 1-800-510-8734
sales@capitalplay.com
www.capitalplay.com

DIGGING THE HOLE

Time required

This will vary depending on trampoline size, equipment used and soil conditions. The Capital In-ground trampolines have been designed to minimize the need to excavate too much soil. If you have a mini-digger (excavator) then the hole excavation will only take a couple of hours.

If you're hand digging then allow a full day for 2-4 people to dig the hole, assemble the trampoline and do the finishing landscaping.



2 hours -
1 day

Equipment Needed

For the smaller size trampolines, it's a relatively easy task to hand dig the hole. For the larger sizes, it's quicker and easier to hire a mini digger/excavator (and operator). The mechanical digger (excavator) should be able to excavate most of the soil to leave you with the hand finishing. You will need a spirit level, a tape measure and you may find a can of 'grass spray' helpful for marking out the hole, although this is not essential.



Hole Dimensions for Rectangular In-ground Trampoline

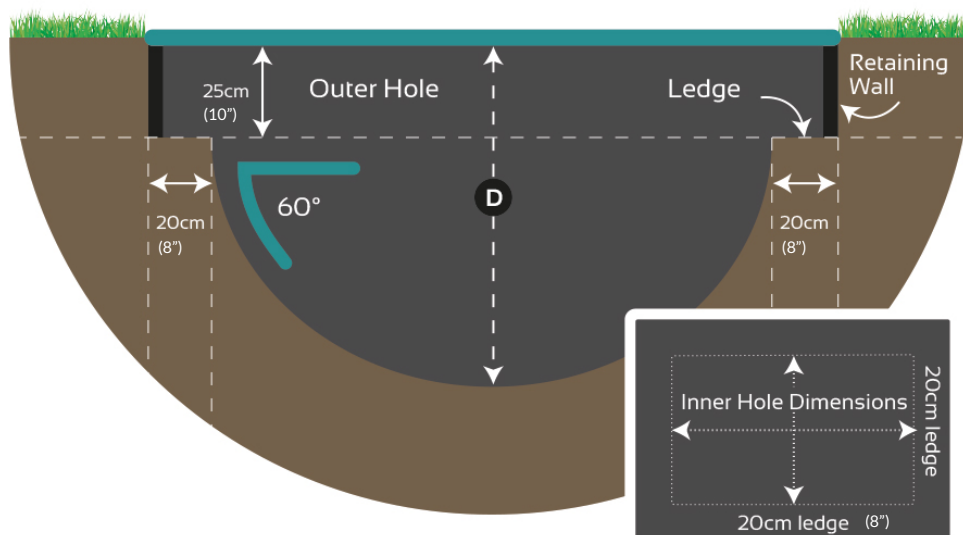

Trampoline Size /Outer Hole Dimensions	Inner Hole Dimensions	D Hole Depth
10' x 6' (3.05m x 1.85m)	8' 8" x 4' 8" (2.65m x 1.45m)	75cm (30")
11' x 8' (3.35m x 2.45m)	9' 8" x 6' 8" (2.95m x 2.05m)	75cm (30")
14' x 10' (4.25m x 3.05m)	12' 8" x 8' 8" (3.85m x 2.65m)	90cm (35")

DIGGING THE HOLE

1

Mark out the hole

It's best to mark out a hole around 4 inches (10cm) wider than the dimensions of your trampoline. This will make it easier for you to put the frame in and find the right level and this gives you some tolerance.

At the end of the install you back-fill between the outside of the hole and the trampoline wall with soil you have saved and then re-turf.



2

Dig the outer hole

The next step is to start digging the main hole for your trampoline frame and retaining wall.

This needs to be 25cm (10") deep, which is the right frame height. The vented pads sit on top of the frame so they will be just above the grass level.

Save around 3 wheel-barrows of top soil for backfilling around the trampoline.

If you have removed turf, save around a third of the removed turf for 'finishing off' around the trampoline once installed.



3

Dig the inner hole

The next stage is to dig the inner hole so that the trampoline will be safe for jumping. Dig this out in a bowl shape to a depth of:

75cm (30") deep for:

10ft x 6ft (3.05m x 1.85m) trampolines

11ft x 8ft (3.35m x 2.45m) trampolines

90cm (35") deep for

14ft x 10ft (4.25m x 3.05m) trampolines

The inner hole is 40cm (16") narrower in diameter than the trampoline size. This will leave a 20cm (8") ledge all around on which the trampoline sits.



Tel: 01276 855600
sales@capitalplay.co.uk
www.capitalplay.co.uk



Tel: 1-800-510-8734
sales@capitalplay.com
www.capitalplay.com

DIGGING THE HOLE

4

Create a soak away

Unless you're confident that your ground will drain well, it's a good idea to build a simple soak-away to allow rain water to drain into the ground and not collect at the bottom of your hole. It's easy and not expensive to do this and does not take long to construct. For a simple, cost effective DIY soak-away, just follow the following instructions:



Dig a new hole at the bottom of the main hole about 2ft (60cms) in diameter and about 2ft (60cms) in depth.



Line the hole with a permeable weed membrane (available at most DIY stores) and fill with scalpings, shingle or just crushed hardcore. The membrane will stop the hole silting up and allow water to collect and drain properly.



Finally wrap the membrane over the top of the hardcore/shingle/scalpings and lay some slabs on top to seal the top. You now have a very effective soak-away.

ATTACH THE RETAINING WALL

Time required

You will need two people to attach the retaining wall to the trampoline frame. You should allow approximately 15 minutes for this stage.



15 mins

Equipment needed

You will need a crosshead screwdriver or electric drill.

Attach the retaining wall panels

1

It is now time to fit the retaining wall to the frame. There are eight Wall Panels with four of them having hole cut-outs only in the corners (these are for the straight sides). Four panels have cut-outs in the corners and four cut-outs in the middle of the wall panel (these are for the corners).

Take one wall panel and lay it against the frame between the upright sections. Insert a Self Tapping Screw with either a hand-held cross-head screwdriver or electric screwdriver, and tighten.

Ensure the wall is as flush to the frame as possible.



2

Fit the remaining panels

Go round the entire frame attaching the remaining panels in the same way until your retaining wall is complete.



Tel: 01276 855600
sales@capitalplay.co.uk
www.capitalplay.co.uk



Tel: 1-800-510-8734
sales@capitalplay.com
www.capitalplay.com

PLACING THE TRAMPOLINE IN THE HOLE

Time required

With two people you should allow approximately 60 minutes for this stage.



60 mins

1

Lift the frame (with retaining wall attached) into the hole and onto the ledge you've created.

Check the levels are correct - you may want to remove the whole trampoline to make any adjustments to the height that the frame is sitting. You are aiming for the trampoline jump mat to sit flush with the ground.



2

Install your weed membrane

Once level, lift the trampoline out of the hole and install the weed membrane.

We recommend you always add a permeable weed membrane to the hole before putting in the trampoline. Make sure the membrane 'hugs' the shape of the hole and sits right at the bottom of the hole - keeping well clear of the jump area.



3

Place frame back in the hole

We recommend you re-check your levels at this point.



ATTACH THE MAT & SPRINGS

Time required

You will need two people to attach the mat and springs.
You should allow approximately 30 minutes for this stage.



30 mins

Equipment needed

Spring tool (supplied), protective gloves and goggles.

1

Spread out the jumpmat

Lay the Jump Mat inside the frame of the trampoline with the centre logo facing upwards.



2

Attach the 4 corner springs to the jump mat

Start by passing springs through the loops on the underside of each corner of the jump mat before securing it to the trampoline.

The corner springs may look and remain stretched. Do not worry, these are high quality springs and you cannot overstretch them.



3

Attach the remaining springs

Attach a spring in the 12 o'clock position, 6 o'clock, 3 o'clock and 9 o'clock positions. Then attach the remaining springs working in opposite positions to keep an even tension on the jump mat. It may help to work with another person to attach these.

Once the jump mat is fitted you may want to carefully jump around the edge of the trampoline to make sure the hole is deep enough and you are not coming into contact with either the sides or the bottom of the hole.

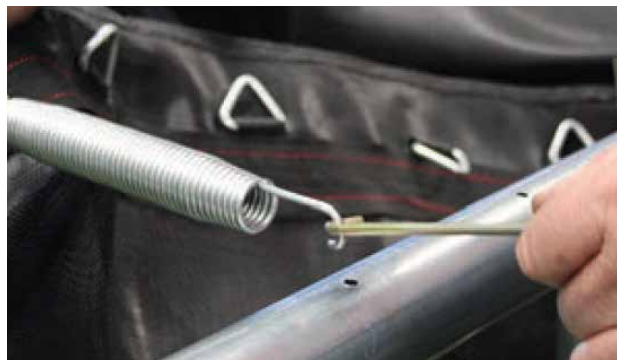

Handy Hint

You will need to use the Spring Tool to attach the springs to the frame. Wearing gloves, hook the spring tool onto the end of a spring, and pull until the spring can be slotted into the correct slot in the frame.

During assembly it may look like the mat won't fit. It will however stretch to the correct size when attaching the springs and this may take a little force. You cannot overstretch a spring.



Tel: 01276 855600
sales@capitalplay.co.uk
www.capitalplay.co.uk



Tel: 1-800-510-8734
sales@capitalplay.com
www.capitalplay.com

BACKFILL THE HOLE

Time required

You will need two people to back fill the hole around the sides of the trampoline.

Equipment needed

Spade and rammer (or the handle end of your spade).



20 mins

1

Backfill the hole:

Fill in the outside of the trampoline with the topsoil you've saved from your hole and compact the soil to ensure a tight finish between your garden and the trampoline.

There should be **NO GAP** between your garden and your trampoline.



2

Re-lay Turf:

Then re-lay the saved turf around the trampoline and compact down as much as possible.



ATTACH THE VENTED PADS

Time required

You should allow approximately 20 minutes for this stage.

Equipment needed

Flat head screwdriver.



20 mins

1

Spread out the safety pads upside down and attach the toggles.

Kneeling on the inside of the pads, feed the Elastic Toggles through the two eyelets so the loop end of the tie faces outwards and the toggle end is on the inside.

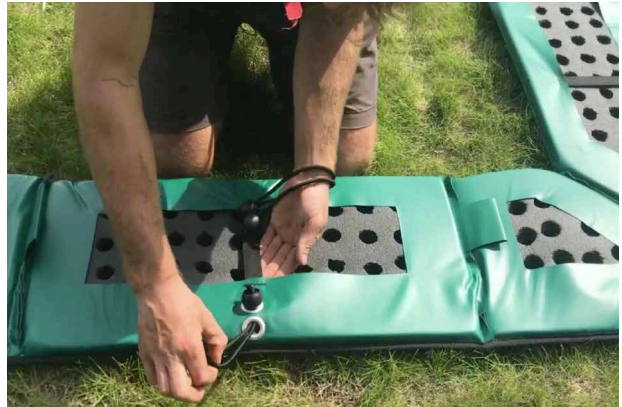

2

Position the pads the correct way up onto the trampoline. Push the loop end of the toggle between the wall panel and frame.

From underneath, insert the toggle into the loop and rotate to secure the pads to the frame. Repeat for all ties.



Handy Hint

To create a gap between the wall and frame, you may need to insert your flat-head screwdriver and rotate to create a gap.

3

To finish installing your pads, remove a single spring underneath where each pad section joins the next one. Then insert the spring through the loop on the underside of the pad and re-attach the spring. This will stop the front of the pads lifting up.



Tel: 01276 855600
sales@capitalplay.co.uk
www.capitalplay.co.uk



Tel: 1-800-510-8734
sales@capitalplay.com
www.capitalplay.com

INSTALLING YOUR ENCLOSURE



Time required

You should allow approximately 20 minutes for this stage.



20 mins

Instructions for full, side and corner net enclosure for rectangular Capital In-ground Trampoline.

10ft x 6ft (3.05m x 1.85m)

11ft x 8ft (3.35m x 2.45m)

14ft x 10ft (4.25m x 3.05m)

ENCLOSURE PARTS LIST



Metal Enclosure Poles	Sleeved Netting with Foam Inserts
(Full Enclosure): 8 (Side Enclosure): 4 (Corner Enclosure): 6	1



Tel: 01276 855600
 sales@capitalplay.co.uk
 www.capitalplay.co.uk



Tel: 1-800-510-8734
 sales@capitalplay.com
 www.capitalplay.com

FULL ENCLOSURE INSTRUCTIONS

1

Take the Enclosure Net complete with foam inserts and lay flat on the trampoline mat with the zip entrance facing towards you.

2

Insert 2 enclosure poles into the sleeves on either side of the zip in positions 1 and 2 of this diagram. Then insert 2 further poles opposite the first two, in positions 5 and 6.

3

Insert each of the poles into the correct enclosure socket through the 10cm (4") slot between the pad sections (see picture below).

4

Finally with the enclosure now half-assembled and upright, insert the remaining poles into the sleeves in positions 3, 4, 7 and 8 and then into the enclosure sockets. The bottom of the net runs along the vented pads and is not tied off in any way.

HALF ENCLOSURE INSTRUCTIONS

1

Take the Enclosure Net complete with foam inserts and lay flat on the trampoline mat.

2

Insert all enclosure poles into the sleeves.

3

Insert each of the poles into the enclosure sockets (on whichever side you want the net) through the 10cm slot between the pad sections (see picture below).

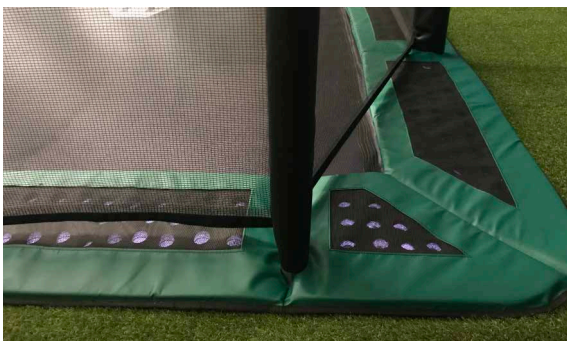



WARNING! ADULT SUPERVISION AND INSTRUCTION IS REQUIRED AT ALL TIMES.

Maximum user weights are:

10ft x 6ft / 3.05m x 1.85m
100kgs

11ft x 8ft / 3.35m x 2.45m
100kgs

14ft x 10ft / 4.25m x 3.05m
120kgs

Make sure the trampoline is placed on a level surface and free of obstacles.

Ensure an area within a radius of 2 meters is free of obstacles and objects.

Do not position the trampoline near obstacles such as fences, trees, balconies, washing lines or obstacles located over the trampoline.

Ensure there is sufficient head space above the trampoline.

Suitable for outdoor use only.

Recommended age: 6+ years.

Keep all sources of heat and flames away from the product as it will burn.

Do not use the mat when it is wet.

Practice without shoes.

Empty your pockets before using the trampoline.

Do not eat food, sweets or chew gum when bouncing.

Always jump in the middle of the mat.

How to stop bouncing safely. You stop by bending your knees as you touch down on the trampoline.

Do not jump off the mat - always walk on and off. Do not jump from other items onto the trampoline.

Limit the time of continuous usage (make regular stops).

Misuse and abuse of the trampoline is dangerous and can result in serious injury.

Do not use the trampoline if under the influence of alcohol or drugs.

Use gloves to protect your hands from pinch points and sharp points during assembly.

Do not apply excessive force during assembly that will cause damage to the product.

This trampoline is intended to be buried into the ground.

Installation of the trampoline requires a hole to be dug in the ground. If you are not sure about the ground work, please contact a professional.

The trampoline shall be assembled by an adult in accordance with the assembly instructions and thereafter checked before the first use.

The hole for the trampoline should not be allowed to accumulate water so if your ground does not drain well, you must provide a drainage solution. The area under the trampoline should be accessible so that it can be cleaned during maintenance.

You must ensure that there is no gap between the trampoline and its retaining wall system and the ground. Ensure that it is not possible for a foot to be trapped.

Avoid somersaults and flips which may result in you landing on your head or neck.

Avoid bouncing when tired.

Only 1 user allowed at a time. Collision hazard.

Many jumpers increase the chances of loss of control, collision and falling over. This can result in serious injury to head, neck, arms or legs.

The trampoline shall be assembled by an adult in accordance with the assembly instructions and thereafter checked before the first use.

Always close the net before jumping.

Installation of the trampoline requires a hole to be dug into the ground. If you are not sure about the ground-work, please contact a professional.





WARNING! ADULT SUPERVISION AND INSTRUCTION IS REQUIRED AT ALL TIMES.

Maximum user weights are:

10ft x 6ft / 3.05m x 1.85m	11ft x 8ft / 3.35m x 2.45m	14ft x 10ft / 4.25m x 3.05m
220lbs	220lbs	264lbs

Assembly and Installation Safety

- Adequate overhead clearance is essential. A minimum of 24 ft from ground level is recommended.
- Provide clearance for wires, tree limbs, and other possible hazards.
- Lateral clearance is essential. Place the trampoline away from walls, structures, fences, and other play areas.
- Maintain a clear space on all sides of the trampoline.
- Place the trampoline on a level surface before use.
- Use the trampoline in a well-lit area. Artificial illumination may be required for shady areas.
- Secure the trampoline against unauthorized and unsupervised use.
- Remove any obstructions from beneath the trampoline.

Care and maintenance

Inspect the trampoline before each use and replace any worn, defective, or missing parts. The following conditions could represent potential hazards:

- (1) Missing, improperly positioned, or insecurely attached frame padding,
- (2) Punctures, frays, tears, or holes worn in the bed or frame padding,
- (3) Deterioration in the stitching or fabric of the bed or frame padding,
- (4) Ruptured springs,
- (5) A bent or broken frame,
- (6) A sagging bed, or
- (7) Sharp protrusions on the frame or suspension system.

Warning information

- DO NOT attempt or allow somersaults. Landing on the head or neck can cause serious injury, paralysis, or death, even when landing in the middle of the bed.
- Do not allow more than one person on the trampoline. Use by more than one person at the same time can result in serious injury.
- Use trampoline only with mature, knowledgeable supervision.
- Inspect the trampoline before each use. Make sure the frame padding is correctly and securely positioned. Replace any worn, defective, or missing parts.
- It is a dangerous practice to jump from the trampoline to the ground when dismounting, or to jump onto the trampoline. Do not

use the trampoline as a springboard to other objects.

Stop bounce by flexing knees as feet come in contact with the trampoline bed. Learn this skill before attempting others.

Learn fundamental bounces and body positions thoroughly before trying more advanced skills. A variety of trampoline activities can be carried out by performing the basic fundamentals in various series and combinations, performing one fundamental after another, with or without feet bounces between them.

Avoid bouncing too high. Stay low until bounce control and repeated landing in the center of the trampoline can be accomplished. Control is more important than height.

While keeping the head erect, focus eyes on the trampoline toward the perimeter. This will help control bounce.

Avoid bouncing when tired. Keep turns short.

Properly secure the trampoline when not in use. Protect it against unauthorized use.

Keep objects away which could interfere with the performer. Maintain a clear area around the trampoline.

Do not use the trampoline while under the influence of alcohol or drugs.

For additional information concerning the trampoline equipment, contact the manufacturer.

For information concerning skill training, contact a certified trampoline instructor.

Bounce only when the surface of the bed is dry. Wind or air movement should be calm to gentle. The trampoline must not be used in gusty or severe winds.

Read all instructions before using the trampoline. Warnings and instructions for the care, maintenance, and use of this trampoline are included to promote safe, enjoyable use of this equipment.

USING YOUR TRAMPOLINE

- Inspect the trampoline before each use. Any damaged or worn parts must be replaced.
- Make sure there are no children, animals or obstructions underneath the trampoline.
- Don't use when it is wet or windy as this may cause you to fall and injure yourself.
- Always bounce in the middle of the mat and practice bouncing techniques safely with adult supervision and guidance.

BOUNCING SKILLS

Basic Bounce

- 1 Start from a standing position with feet a shoulder width apart, head up and eyes on the trampoline mat.
- 2 Swing arms forward and up above head in a circular motion.
- 3 Bring legs and feet together in mid-air position and point toes.
- 4 Land back on the mat with feet a shoulder width apart (the same as the start position).



Knee Drop

- 1 Start with a low basic bounce.
- 2 Land on knees shoulder width apart, keeping back straight and a strong body position using arms out to the side or in front to maintain balance.
- 3 Bounce back to basic bounce position by using bounce momentum and swinging arms above head.
- 4 Once mastered at this height try bouncing a little higher, but remember to always stay in control of your height.

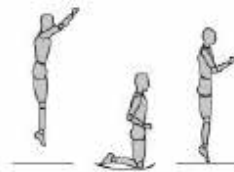

Hand & Knee Drop

- 1 Land on your hands and knees at the same time, ensure your back is horizontal to the bounce mat and hands and legs are shoulder width apart also.
- 2 Push off from hands and knees and recover the upright vertical position.



Seat Drop

- 1 Start with the low basic bounce (Basic Skill 1) in the normal position.
- 2 Land with legs out straight in front of you, with hands either side of your hips and back straight in a strong body position.
- 3 Use the bounce momentum sided with a push from hands to return to a standing position.
- 4 Once mastered at this height try bouncing a little higher, but remember to always stay in control of your height.











CARE AND MAINTENANCE

Regular care and maintenance of your trampoline is required – you should check your trampoline once a month. This will help prolong its life and reduce the possibility of injury. Neglecting this can lead to a risk for users.

Inspect your trampoline before each use using the checklist below as a guide. Take particular care in doing this at the start of each season and at regular intervals. Ensure all parts are intact and cannot become dislodged during play, tighten any screws or nuts and bolts where required.

IMPORTANT: If any faults are found, the trampoline MUST NOT BE USED. We advise that the trampoline is dismantled and put in a dry place until replacement parts are fitted.

Part	Checklist	OK	Not OK
All Parts	Securely attached Correctly positioned No sharp edges or points present No missing parts		
Springs	No damage (bent / broken) No missing parts		
Frame	No bent parts No damage No rusting or corrosion		
Mat/Pad/Net	No missing parts (e.g. D-rings, ties) No sagging No damage (e.g. holes, rips, fraying, tearing)		

**Use trampoline as advised on the safety guides in this manual.
Excess weight and improper use will damage it and cause it to break easily.**

Keep trampoline clean. If any part becomes dirty, clean with a damp cloth and dry thoroughly.

Do not use any abrasive cleaners as this could damage the products.

Store pads in dry place when not in use. Prolonged exposure to sun and harsh weather can shorten its life.

Keep mat in good condition by using a cover. (Available to buy from our website). Damage can be caused by water pooling, garden/outdoor debris landing on it, and sparks from nearby bonfires and fireworks displays.



Follow instructions
carefully



We're here to help
UK: 01276 855600
USA: 1-800-510-8734



Seriously happy
kids guaranteed!



Tel: 01276 855600
sales@capitalplay.co.uk
www.capitalplay.co.uk



Tel: 1-800-510-8734
sales@capitalplay.com
www.capitalplay.com

Capital Play Ltd. 2/3 Higher
Park Farm, Halebourne Lane,
Chobham, Surrey, GU24 8SL.

Authorised Worldwide Dealers

ACTION FITNESS
+64 (03) 366 6959
chris@actionfitness.co.nz
www.actionfitness.co.nz

OZ TRAMPOLINES
+61 (1) 300 393 004
sales@oztrampolines.com.au
www.oztrampolines.com.au

TRAMPOLINES.NL
+31 (0) 74 349 46 50
info@trampolines.nl
www.trampolines.nl

TRAMPOLINE-SHOP.DE
+31 (0) 74 349 4650
info@trampoline-shop.de
www.trampoline-shop.de